

FCP IT-tool - Preview

User manual

Ver 0.1 - alpha

H. Ekestam

2023-05-29

Disclaimer

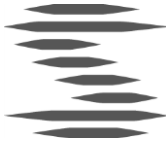
The present version of the tool is a preview, representing a work in progress. The tool will be utilized for evaluation of the outlined requirements for the prequalification of new FCR-providing units. Bugs and missing functionality is expected to occur. Thus, they will be corrected in parallel with prequalification of new FCR-providing units.

Furthermore, it is vital to emphasize that the purpose of this document (User manual) is to provide guidelines and explanations on the use of the tool itself. While the necessary tests to perform, to prequalify for FCR-N and FCR-D, are outlined in this document, the actual requirements are stated in the FCR technical requirements document.

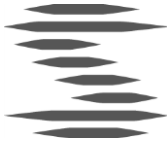


Table of contents

1	Introduction	4
1.1	<i>General outline of usage</i>	4
2	Prequalification tests	6
2.1	<i>Sine response test</i>	6
2.2	<i>Step response test (FCR-N)</i>	6
2.3	<i>Linearity test (FCR-N)</i>	7
2.4	<i>Active frequency control test (FCR-N)</i>	8
2.5	<i>Ramp response test (dynamic FCR-D)</i>	8
2.6	<i>Ramp response test (Static FCR-D)</i>	8
2.7	<i>Active data logging (FCR-D)</i>	9
2.8	<i>Test of frequency measurement equipment</i>	9
2.9	<i>Data structure for recorded measurement data</i>	9
2.9.1	<i>Sampling rate and resolution</i>	10
2.9.2	<i>CSV-files</i>	10
2.9.3	<i>JSON-files</i>	12
2.9.4	<i>Comparison CSV – JSON</i>	14
3	Usage of the tool	15
3.1	<i>How to run</i>	15
3.2	<i>Initiate analysis</i>	15
3.3	<i>Manual entry of step parameters</i>	16
3.4	<i>Partial sine sweep analysis</i>	16
3.5	<i>Plot window</i>	17
4	Theory.....	19
4.1	<i>FCR-N – General</i>	19
4.2	<i>FCR-N - Plots</i>	21
4.2.1	<i>Step response</i>	21
4.2.2	<i>Sine sweeps</i>	21
4.2.3	<i>F Bode</i>	22
4.2.4	<i>FCR circles</i>	23
4.2.5	<i>Sensitivity Bode</i>	24
4.2.6	<i>Stability Nyquist</i>	25



4.2.7	<i>Performance Bode</i>	26
4.3	<i>FCR-D – General</i>	27
4.4	<i>FCR-D - Plots</i>	27
4.4.1	<i>Ramp response</i>	27
4.4.2	<i>Sine sweeps</i>	27
4.4.3	<i>Stability Nyquist</i>	28
4.4.4	<i>Linearity</i>	29
5	References	29
	Appendix A: Step response regression model	31
5.1	<i>Gauss-Newton method</i>	31
5.2	<i>Regression model</i>	32



1 Introduction

Svenska Kraftnät is on behalf of the Nordic TSOs preparing a preview version of an IT Tool aimed at automatically evaluating the proposed new technical requirements of FCR.

The main idea behind the development of the FCP IT-tool has been to contribute to a smooth transition from the preceding requirements on FCR-N and FCR-D respectively, to the requirements proposed by the series of *Frequency Containment Process* projects (FCP). One aim is for the tool to be used by the assessing *Transmission system operator* (TSO) to provide a standardised evaluation process during prequalification and contribute to a fair and equal assessment. Another aim is that the provider that is to be assessed shall be able to use the tool during the test and tuning process as well as when preparing the prequalification application.

This document contains a practical description of how the tool is used in the section *Usage* below, and a more theoretical description of the calculations in the section *Theory*. A brief description of the prequalification tests to be performed as well as documentation of how measurement data is to be presented to the tool is given in the section *Prequalification tests* below.

1.1 General outline of usage

A general outline of the processes surrounding the use of the tool is given in the illustration on the page that follows. Preceding the use of the tool is a test process in which the provider to be prequalified is to perform the required step, ramp, and sine response tests. The provider is also expected to complete any data processing necessary to have the test data on a format readable by the tool. The second phase is where the FCP IT-tool operates. Here the provider may study the test data and either decide to initiate a formal application using the achieved results or to try retuning the unit and perform testing again. The third phase commences when the provider is satisfied with the results and analyses from the tool and decides to initiate the formal application process with the approving TSO.

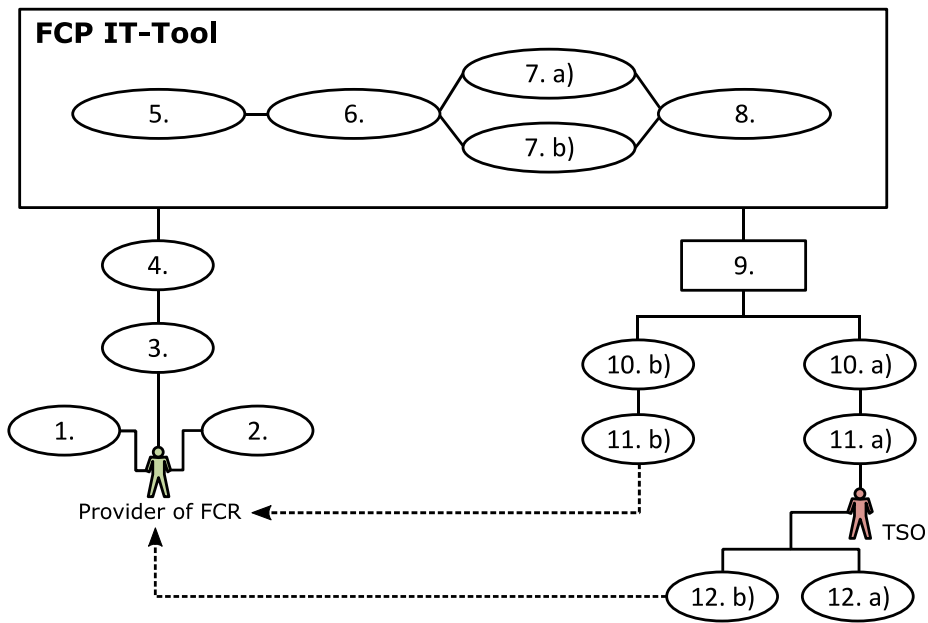


Figure 1. Outline of the process surrounding the use of the tool. Each step is presented in the table below.

Test process	FCP IT-Tool	Evaluation process
1. Step / ramp response test 2. Sine sweep test 3. Local data processing 4. Input to the FCP IT-Tool	5. Data import 6. Calculation of transfer functions, normalisation factors, capacity, etc. 7. a) Evaluation: Approved / Not approved b) Visualisation of data, margins to requirements, etc. 8. Possibility to export data and plots	9. The applying provider examines results at test site 10. a) Provider satisfied with results b) Provider not satisfied with results 11. a) Formal application sent to TSO b) Iterate → Step 1. 12. a) Formal evaluation and approval b) Rejection



2 Prequalification tests

This section contains a brief description of the tests to be conducted as well as a discussion of specifics in relation to the FCP IT-tool evaluation process. The possible data formats for input into the tool is specified in the last subsection. A more theoretical view of how the measurement data is used in the calculations is given in the section *Theory* below. For a more in-depth description of the testing procedure, please see the Main document on the technical requirements as well as the Test program.

2.1 Sine response test

A sequence of sine tests must be performed to demonstrate that the FCR-providing unit can react to varying frequency dynamics in an appropriate way. The periods for full evaluation of FCR-N is presented in Table 1 below. The corresponding periods for dynamic FCR-D upwards and FCR-D downwards is presented in Table 2.

10	15	25	40	50	60	70	90	150	300
----	----	----	----	----	----	----	----	-----	-----

Table 1. Periods in seconds for the FCR-N sine sweep.

10	15	25	40	50	60	70	90	150	300
----	----	----	----	----	----	----	----	-----	-----

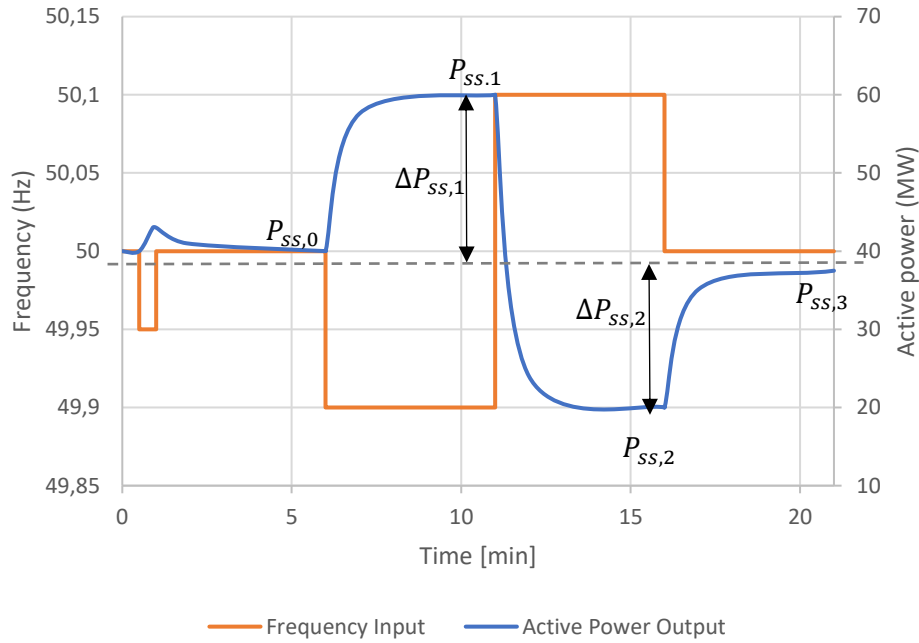
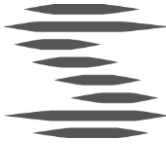
Table 2. Periods in seconds for the dynamic FCR-D upwards and FCR-D downwards sine sweep. Dashed outline indicates periods which may sometimes be omitted, see the technical requirements for details.

The FCP IT-tool is able to perform a partial analysis if only measurements from a subset of the stipulated periods are supplied. This means that the user can get an early indication of failure to achieve the requirements, e.g. during the tuning and testing process. It is thus possible to perform only some of the sine sweeps and then start an analysis with the tool to determine if the current results seem promising enough to perform the full test suit, or if re-tuning is already seen to be needed.

Please note that to achieve final qualification the full set of periods must be supplied meeting the stipulated requirements.

2.2 Step response test (FCR-N)

A sequence of step response tests is to be performed for FCR-N qualification to determine a normalisation factor for the sine sweeps as well as the prequalified capacity. The sequence is presented in Figure 2 below.

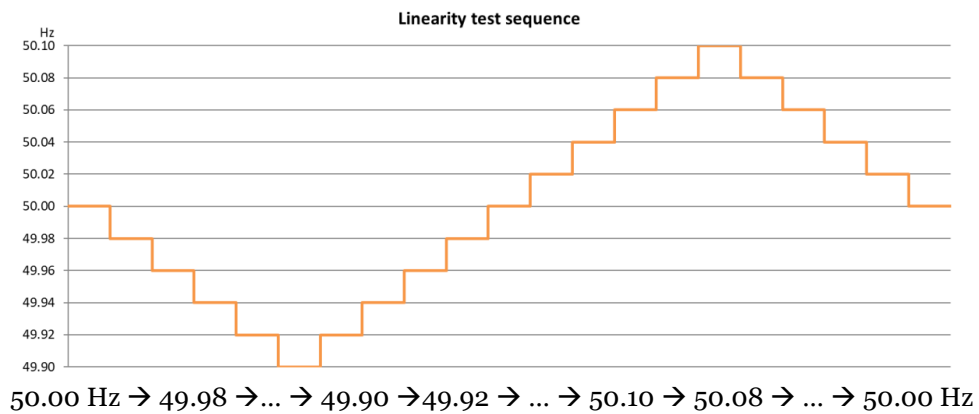


50.00 Hz → 49.95 → 50.00 → 49.90 → 50.10 → 50 Hz

Figure 2. Step sequence for FCR-N.

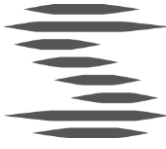
2.3 Linearity test (FCR-N)

If the unit or group has a non-continuous response, e.g. is controlled in a stepwise manner, an additional linearity test shall be performed. The linearity test sequence for FCR-N is illustrated in Figure 3 below.



50.00 Hz → 49.98 → ... → 49.90 → 49.92 → ... → 50.10 → 50.08 → ... → 50.00 Hz

Figure 3. Linearity test sequence for FCR-N.



2.4 Active frequency control test (FCR-N)

All FCR-N providing entities shall perform a test with 1 hour of active frequency control based on measured grid frequency. Functionality for analysing this test will in the future be implemented in the IT-Tool.

2.5 Ramp response test (dynamic FCR-D)

A ramp response test is to be performed for dynamic FCR-D and is used in the calculation of the available capacity. The test for dynamic FCR-D downwards is presented in Figure 4 below. Static FCR-D shall apply a separate test, different from the one provided in this section. The equivalent test for dynamic FCR-D upwards is mirrored compared to Figure 4.

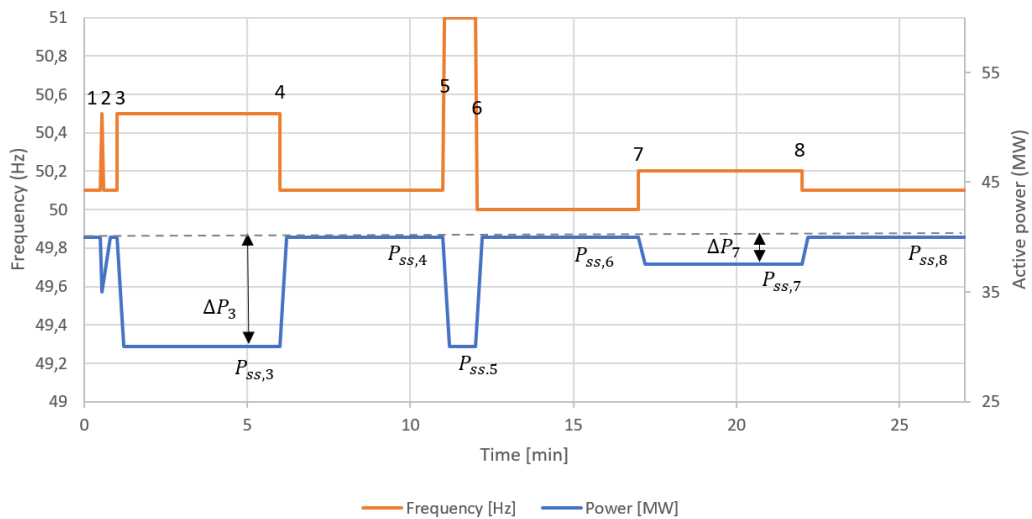


Figure 4. Ramp sequence for dynamic FCR-D downwards

2.6 Ramp response test (Static FCR-D)

A ramp response test is to be performed for Static FCR-D and is used in the calculation of the available capacity. The test for static FCR-D downwards is presented in Figure 5 below. The equivalent test for static FCR-D upwards is mirrored compared to Figure 5.

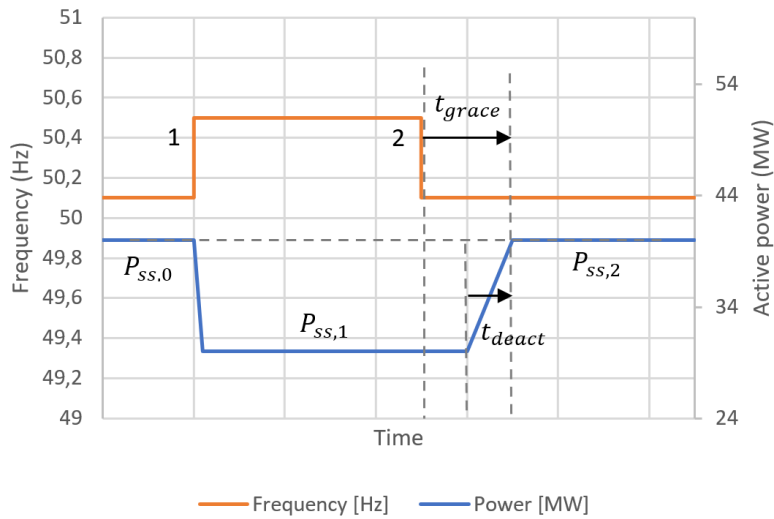
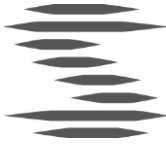


Figure 5 . Ramp sequence for static FCR-D downwards

2.7 Active data logging (FCR-D)

All FCR-D upwards and FCR-D Downwards providing entities shall perform a test with 1 hour of active data logging, including measured grid frequency.

Functionality for analysing the logged data will be considered for implementation in the IT-Tool.

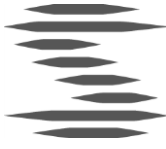
2.8 Test of frequency measurement equipment

If the frequency measurement loop is omitted from the test process of any of the FCR products, by e.g. applying an internal frequency signal to the controller, the time delay of the frequency measurement loop needs to be separately determined using one of four options as defined in the document *FCR Technical Requirements* (see References). One option is to perform a separate test of the frequency measurement loop, by inserting an externally generated frequency step response to measure the time constant of the response.

Functionality to analyse this test is currently not implemented in the IT-Tool.

2.9 Data structure for recorded measurement data

The measurement data from the prequalification test process shall be provided in either .csv or .json format as explained in the technical requirements. Additional information on the expected structure of such files is detailed in the sections that follow. A brief comparison of the advantages of the respective format is given in the section *Comparison CSV – JSON* below.



2.9.1 Sampling rate and resolution

The accuracy, resolution and sampling rate of logged data shall be per the technical requirements. The IT tool will nevertheless use the supplied data and try to make a correct analysis irrespective of the sampling rate and resolution of the input data.

2.9.2 CSV-files

The first row of each Csv-file shall be a header defining the meaning of each column. Csv-files should preferably be delimited with comma (“,”) with decimal separator being a point (“.”). Alternatively the delimiter can be semi-colon (“;”) with decimal separator being a comma (“,”). The character encoding shall be UTF-8 where record delimiter is carriage return (↵ ASCII/CRLF=0x0D 0x0A).

Each test shall be supplied in a separate Csv-file. The format for the non-sine tests is shown in Example 1 below. At least three columns have to be supplied:

- “DateTime” – represents the date and time when the sample as recorded, in the format [YYYY-MM-DDThh:mm:ss.nnn], where n are decimal fractions of a second. Alternatively, the format YYYYMMDDThhmmss.nnn may be used.
- “GridFreq” – represents the frequency during the test in [Hz]. The resolution of the logged frequency must be able to capture frequency deviations of 5 mHz.
- “InsAcPow” – represents the total active power in [MW], or alternatively, the FCR response during the test, in [MW]. The resolution of the logged active power must be able to capture changes of 10 kW, or 0.025% of the rated active power.

The columns “GridFreq” and “InsAcPow” may alternatively be renamed using the aliases “u” and “y” respectively. The DateTime column may optionally be replaced by a column indicating the running number of seconds since the start of the test.

- “t” – represents the time offset from the start of the test in [seconds]

Additional columns may be supplied in the file. They shall use the naming scheme defined in the technical requirements.



```
DateTime, GridFreq, InsAcPow
2021-05-24T12:00:03.000, 50.000, 1.000
2021-05-24T12:00:03.100, 50.000, 1.000
2021-05-24T12:00:03.200, 50.000, 1.000
2021-05-24T12:00:03.300, 50.000, 1.000
2021-05-24T12:00:03.400, 50.000, 1.000
2021-05-24T12:00:03.500, 50.000, 1.000
2021-05-24T12:00:03.600, 50.000, 1.000
2021-05-24T12:00:03.700, 50.000, 1.000
2021-05-24T12:00:03.800, 49.500, 1.100
2021-05-24T12:00:03.900, 49.500, 1.401
2021-05-24T12:00:04.000, 49.500, 1.702
...
```

Example 1. Expected structure of csv-file for **step**, **ramp** and **linearity** response data. Only a few rows are shown.

The user may name each of the step/ramp/linearity csv-files arbitrarily but is recommended to use the naming scheme defined in the technical requirements.

The structure of the sine-sweep csv-files is similar to the above. Each sine sweep shall be put into its own file, separated by the period of the applied sine signal. The period has to be appended to each column header for the tool to correctly identify the signals, as shown in Example 2 for a period time of 40 seconds.

Note that only the stable part of the power response is to be supplied to the tool for the sine sweeps. This implies that transients or oscillations that occur prior to the stable part of the power response should be excluded in the logged data for the tool.

```
DateTime40, GridFreq40, InsAcPow40
...
2021-05-24T12:00:18.100, 50.04067, 6.36615
2021-05-24T12:00:18.200, 50.041945, 5.13588
2021-05-24T12:00:18.300, 50.043208, 3.50987
2021-05-24T12:00:18.400, 50.044463, 1.59796
2021-05-24T12:00:18.500, 50.045709, -0.52102
2021-05-24T12:00:18.600, 50.04694715, -2.79047
2021-05-24T12:00:18.700, 50.048175, -5.16968
2021-05-24T12:00:18.800, 50.049394, -7.62934
2021-05-24T12:00:18.900, 50.050603, -10.1482
2021-05-24T12:00:19.000, 50.051802, -12.7111
...
```

Example 2. Expected structure of csv-file for **sine** response data. Only a few rows are shown. The "40" in the header row represents a period time of 40 seconds for this particular sine signal.



The user may name each of the sine csv-files arbitrarily but is recommended to use the naming scheme defined in the technical requirements. The folder which contains the sine-sweep files may not contain any other csv-files than the collection of sweeps related to a single FCR qualification sequence. The reason for this is that the user supplies the tool with the path to one of the csv-files, and then the tool searches iteratively through the containing folder for the rest of the sine sweep responses. Other csv-files in that folder may then incorrectly be interpreted as sine sweep responses.

The tool will in a future version have the ability to infer the period time from the file name, if correctly supplied. The csv-files will then be formatted as in Example 1 above.

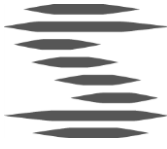
2.9.3 JSON-files

JavaScript Object Notation (JSON) is a data exchange format based on the syntax of the programming language Javascript, which share many similarities with various other languages, including Matlab and Python. Use of JSON-files is offered as an alternative data input format for the FCP IT-tool. The format for the non-sine test files is shown in Example 3 below. At least three vectors shall be supplied:

- “DateTime” – represents the date and time when the sample was recorded, in the format `[YYYY-MM-DDThh:mm:ss.nnn]`, where `n` are decimal fractions of a second. Alternatively, the format `YYYYMMDDThhmmss.nnn` may be used.
- “GridFreq” – represents the frequency during the test in [Hz].
- “InsAcPow” – represents the total active power in [MW], or alternatively, the FCR response during the test, in [MW].

The vectors “GridFreq” and “InsAcPow” may alternatively be renamed using the aliases “u” and “y” respectively. The DateTime column may optionally be replaced by a column indicating the running number of seconds since the start of the test. See example 4 below.

- “t” – represents the time offset from the start of the test in [seconds]



Additional vectors may be supplied in the file. They shall use the naming scheme defined in the technical requirements.

```
{  
  "DateTime" : [2021-05-24T12:00:18.100, 2021-05-24T12:00:18.100, ...],  
  "GridFreq" : [50, 50.012533, 50.024868, ...],  
  "InsAcPow" : [1, 4.276369, 12.815004, ...]  
}
```

Example 3. Expected structure of json-file for **step, ramp** and **linearity** response data. Only a few samples in each vector are shown.

The user may name each of the step/ramp/linearity json-files arbitrarily but is recommended to use the naming scheme defined in the technical requirements.

The structure of the sine-sweep json-file is similar to the above. Each sine sweep vector shall be given a suffix, indicating the period time of the corresponding sine signal. The expected structure is illustrated in Example 4 below.

Note that only the stable part of the power response is to be supplied to the tool for the sine sweeps.



```
{
  "t10" : [0,0.2,0.4,0.6,0.8,1,1.2,...],
  "t15" : [0,0.2,0.4,0.6,0.8,1,1.2,...],
  "t25" : [0,0.2,0.4,0.6,0.8,1,1.2,...],
  "t40" : [0,0.2,0.4,0.6,0.8,1,1.2,...],
  "t50" : [0,0.2,0.4,0.6,0.8,1,1.2,...],
  "t60" : [0,0.2,0.4,0.6,0.8,1,1.2,...],
  "t70" : [0,0.2,0.4,0.6,0.8,1,1.2,...],
  "u10" : [0,0.012533,0.024868,0.036812,0.048175,0.058778,0.068454,...],
  "u15" : [0,0.008367,0.016676,0.024868,0.032886,0.040673,0.048175,...],
  "u25" : [0,0.005024,0.010036,0.015022,0.019970,0.024868,0.029704,...],
  "u40" : [0,0.003141,0.006279,0.009410,0.012533,0.015643,0.018738,...],
  "u50" : [0,0.002513,0.005024,0.007532,0.010036,0.012533,0.015022,...],
  "u60" : [0,0.002094,0.004187,0.006279,0.008367,0.010452,0.012533,...],
  "u70" : [0,0.001795,0.003589,0.005382,0.007174,0.008963,0.010750,...],
  "y10" : [0,4.276369,12.815004,18.845685,21.376654,20.787510,17.680483,...],
  "y15" : [0,2.855088,8.580846,12.706930,14.605754,14.544086,12.918230,...],
  "y25" : [0,1.714336,5.160059,7.668363,8.873458,8.940477,8.106950,...],
  "y40" : [0,1.071735,3.227514,4.802220,5.5695820,5.633979,5.143951,...],
  "y60" : [0,0.714555,2.152264,3.203735,3.718682,3.766978,3.447676,...],
  "y70" : [0,0.612487,1.844905,2.746469,3.188466,3.230839,2.958498,...]
}
```

Example 4. Expected structure of json-file for **sine** response data. Only a few samples in each vector are shown. The number at the end of each vector name indicates the period time of the corresponding sine signal. Here the aliases “u” and “y” have been used instead of “GridFreq” and “InsAcPow” respectively. The time as been recorded as a running number of seconds.

The user may name the sine sweep json-file arbitrarily but is recommended to use the naming scheme defined in the technical requirements. Unlike for the csv-files, all json-files may be located in the same folder.

2.9.4 Comparison CSV – JSON

The FCP IT-tool supports two different formats for data input – CSV and JSON. The main benefit of the csv-format is that it is well-known and commonly supported among many different software programmes and tools. One disadvantage is that it is not fully standardised, e.g. the data separator may differ between implementations, and a header row may or may not be included. Some advantages of the JSON format are that it is typically easier to manually inspect – and change – specific data than for CSV. It is also a more flexible data format leading to the ability for the FCP IT-tool to combine all sine sweep results into one json-file, where several csv-files are needed. This is because in csv-files it would be cumbersome to combine data vectors of differing lengths.

From a usage point of view the two data formats are equivalent as used by the FCP IT-tool. The determining factor as to which data format a user of the tool should apply is typically which of the two formats the user is most comfortable with.



3 Usage of the tool

3.1 How to run

The tool is provided as an executable package. The tool is started by running the executable file, which consists of the compiled source code together with a Python distribution and several support libraries, collected into one package for ease of use.

3.2 Initiate analysis

An analysis of available measurement data is initiated by setting the desired options in the options pane of the tool, as shown in Figure 6 below.

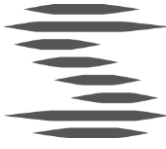
The screenshot shows the 'Options' pane of the tool. It is organized into four columns. The first column, 'Select product', contains three radio buttons: 'FCR-N', 'FCR-D Upwards', and 'FCR-D Downwards'. The second column, 'Step N', contains a list of options: 'Sine', 'Ramp D', 'Linearity', and 'LER'. The third column, 'Select step (N) response data source', contains a text input field, a 'Browse' button, a checkbox for 'Manual entry of step parameters', and a text input field labeled 'e ='. The fourth column, 'Other options', contains four checkboxes: 'Angular frequency' (checked), 'Frequency', 'Time periods', and 'Flip sign of power signals'. A 'Load' button is located at the bottom center of the pane.

Figure 6. Options pane of the tool.

The first column is for the user to select the kind of frequency containment product that is to be evaluated. The user is given a choice of evaluating either FCR-N, FCR-D upwards, or FCR-D downwards in accordance with the proposed requirements to be applied during the pilot phase. Static FCR-D is chosen by ticking the corresponding check box in the sine tab. The user then does not have to supply any sine results, as these are not applicable for Static FCR-D.

The second column of the options pane is used to select the data files containing measurement data from the different tests. The format for **the** data files is explained in detail in the section *Data structure for recorded measurement data* above. Note that all sine sweep response files should be placed in the same folder and that the path to one of them is to be supplied to the tool. Options not applicable to the specified product are disabled, e.g. FCR-D ramp test sequence when FCR-N is selected.

The second column also gives the user the possibility to manually enter results from the FCR-N step sequence or the FCR-D step sequence, thus foregoing the inclusion of such data sets in the analysis. This option is meant to give the user the opportunity to perform preliminary analyses without performing the entire test sequence, thus aiding in speeding up the tuning process. Refer to the section *Manual entry of step parameters* below for a more detailed description of this option.



The third column is for various other options. The option currently available is how the period times from the sine sweeps is to be presented in the Bode diagrams.

3.3 Manual entry of step parameters

The tool presents the user with the option to omit including measurement data for the step sequence(s). This may be of use as the parameters obtained from the step sequences is not directly used in the evaluation towards the FCP-requirements.

Parameters calculated from the step response test(s) is used in the scaling of the sine sweep results, however. The user thus needs to manually enter estimations of these parameters if actual step response measurement data is omitted.

The following parameters are available for manual estimation:

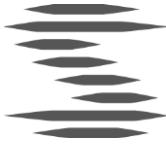
FCR-N: Normalisation factor for sine responses e

FCR-D: Normalisation factor for sine responses e ,
Steady state scaling factor $C/P_{ss,theo}$

The meaning and calculation of each of the parameters is described in more detail in the section *Theory* below. If a parameter is manually entered, the corresponding step sequence may be omitted. A preliminary analysis is then performed by assuming that the value of each manual parameter is correct. Please note that for actual prequalification evaluation a full set of measurement data has to be supplied.

3.4 Partial sine sweep analysis

A partial sine sweep analysis may be initiated by the user by not supplying all of the stipulated period times of the sine sweep tests. The tool will in that case proceed to analyse those sweeps that actually were provided and give a preliminary assessment to the user. This may be used during the tuning process to lower the number of test to perform. E.g. if it is known that the requirements are harder to fulfil for some specific period times, only those period times have to be tested during the initial tuning process, thus speeding up the process. Please note that for actual prequalification a full set of measurement data has to be supplied.



3.5 Plot window

The tool has a capability of generating plots after analysing the provided data. Previews of the generated plots are shown within the main window of the tool. A separate plot window may be opened by double-clicking on a preview, where Figure 7 contains an illustration of such a plot window. The buttons of the window are explained in Table 3.

Options for controlling the appearance of the plot with regards to limits, labels etc. are available by use of the button “Plot options”. The resulting options window is illustrated in Figure 8 below.

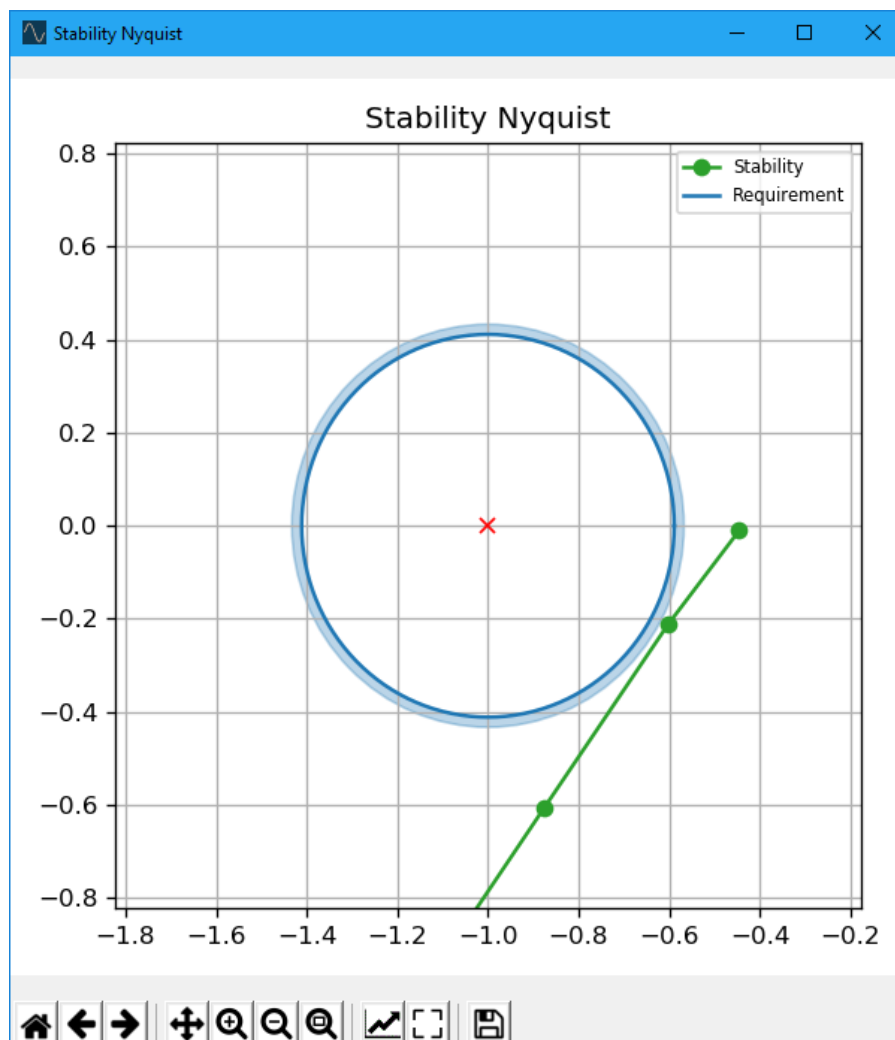












Figure 7. Example of a plot window opened by double-clicking a preview within the tool.

**Table 3.** Description of each button in the plot window.

Image	Function	Description
	Reset to original view	Resets the plot to the original appearance from the preview. Used e.g. if zoomed.
	Back to previous view	Undo the last change to the view, e.g. zooming. Useful to compare different views e.g. different zoom levels. Comparable to the back button of a web browser.
	Forward to next view	Redo the last change to the view, e.g. zooming. Useful to compare different views e.g. different zoom levels. Comparable to the forward button of a web browser.
	Pan axes/ Zoom axes	Use the left mouse button to pan around in the plot by changing the limits of the x and/or y axes. Use the right mouse button to instead zoom the x and/or y axes.
	Zoom in	Press to zoom in
	Zoom out	Press to zoom out
	Zoom to rectangle	Draw a rectangle to set the area of the plot to zoom in to.
	Plot options	Opens a separate window with plot options. See separate description.



	Full screen	Enters and exits full screen mode.
	Save figure to file	Opens a separate window with the option to save the current plot to a file.

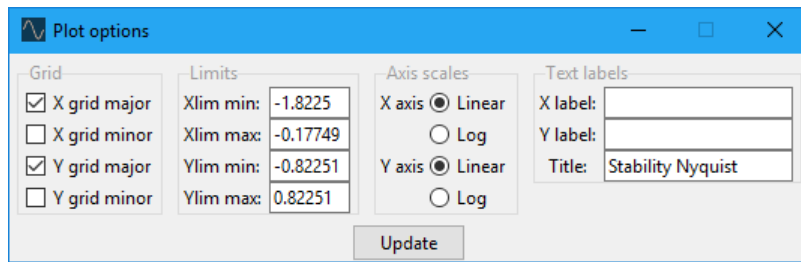


Figure 8. Options for changing the appearance of a plot.

4 Theory

This section contains brief theoretical descriptions of the plots generated by the tool, as well as calculations and equations, which the plots are based on. For a more in-depth description of the requirements, tests to be performed etc., please refer to the documents in the *References* section.

4.1 FCR-N – General

The requirements on performance and stability may be reformulated in several ways. The formulations that are applied by the FCP IT-tool are shown for the performance and stability in Table 4. The corresponding plots as well as interpretations of the formulations are given in the sections that follows.

Note that the FCP requirements allow for a 5 % reduction of the requirements to allow for measurement uncertainties during testing, etc. Such reductions have been omitted from the equations stated in this document but is included in the calculations performed by the tool. The reduction is also illustrated in the Nyquist plot on stability, included in the section *Stability Nyquist* below.

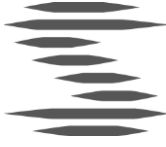


Table 4. Requirements on performance and stability.

Performance circles	Performance sensitivity	Performance Bode
$\left F(s) - \frac{1}{G_{avg}(s)}\right > D(s) $	$ S_{avg}(s) < \frac{1}{ D(s)G_{avg}(s) }$	$\frac{ G_{avg}(s) }{ 1 - F(s)G_{avg}(s) } < \frac{1}{ D(s) }$
Stability circles	Stability sensitivity	Stability Nyquist
$\left F(s) - \frac{1}{G_{min}(s)}\right > \frac{1}{M_s G_{min}(s) }$	$ S_{min}(s) < M_s = 2.31$	$ 1 - F(s)G_{min}(s) > \frac{1}{M_s}$

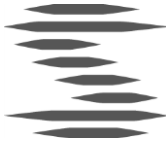
Here $F(s)$ is the transfer function of the FCR-providing unit, $G(s)$ is the transfer function corresponding to the grid and $D(s)$ is the transfer function of the power disturbance. Two representations of the grid are applied corresponding to a scenario with minimal inertia and a scenario with average inertia, denoted $G_{min}(s)$ and $G_{avg}(s)$ respectively. The minimal inertia system is applied to the stability requirement to ensure robust stability even in the case of model uncertainties, while the average inertia system is used for the performance requirement to achieve nominal performance. The sensitivity transfer function is here taken to be $S(s) = 1/(1 - F(s) \cdot G(s))$

The calculation of the transfer function $F(s)$ is described in the sections *Sine sweeps* and *F Bode* below. The transfer function of the grid is defined as

$$G(s) = \frac{600 \text{ MW}}{0.1 \text{ Hz}} \cdot \frac{f_0}{S_n} \cdot \frac{1}{2Hs + k \cdot f_0}, \tag{1}$$

where the constants take the following values for the minimal and average inertia system respectively.

	Minimal inertia	Average inertia
f_0	50 Hz	50 Hz
S_n	23 000 MW	42 000 MW
H	$\frac{120\,000 \text{ MWs}}{S_n}$	$\frac{190\,000 \text{ MWs}}{S_n}$
k	0.01	0.01



4.2 FCR-N - Plots

4.2.1 Step response

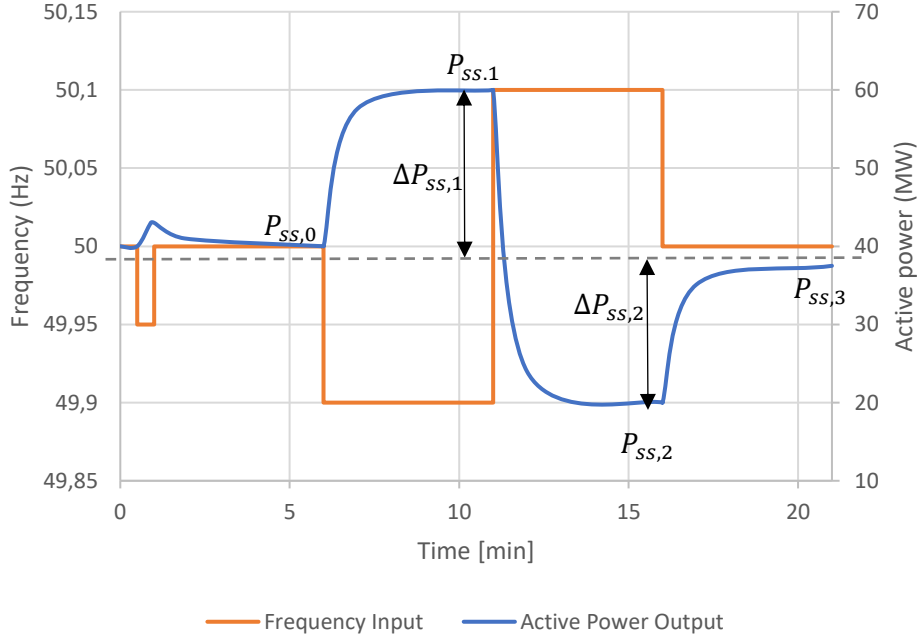


Figure 9. FCR-N sequence with definitions of variables

From the step sequence four responses – ΔP_1 to ΔP_4 – is calculated as shown in Figure 9 above. These values are used by the tool to determine the available FCR-N capacity (C). The responses are also used for scaling of the sine sweep results, as described in the next section. The following equations are applied in the calculations of the capacity:

$$C = \frac{|\Delta P_1| - |\Delta P_0| + |\Delta P_2| - |\Delta P_0|}{2}, \quad (2)$$

4.2.2 Sine sweeps

The sine sweep results are used to estimate the transfer function for the FCR providing unit at the applied angular frequencies. The angular frequency ω corresponding to a period time T is calculated as

$$\omega = \frac{2\pi}{T}. \quad (3)$$

The non-normalised gain of the transfer function at angular frequency ω is calculated as

$$|F_0(j\omega)| = \frac{A_P(\omega)}{A_f(\omega)}, \quad (4)$$

where F_0 is the transfer function, A_p is the amplitude of the measured power response and A_f is the amplitude of the injected sinusoidal signal. The phase shift is calculated as

$$\varphi = \text{Arg}(|F_0(j\omega)|) = \Delta t \frac{(360^\circ)}{T} \quad (5)$$

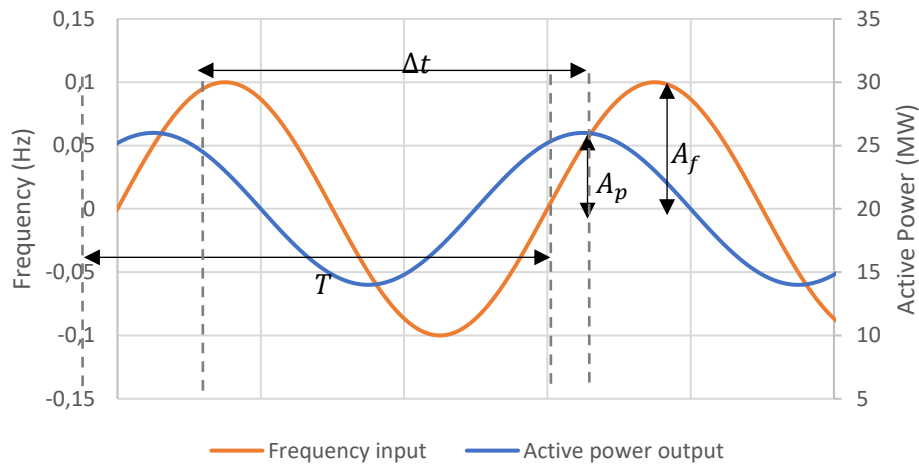


Figure 10. Definitions of parameters calculated from the sine responses.

4.2.3 F Bode

The transfer function F_0 as described above is normalised with a normalisation factor e as

$$|F(j\omega)| = \frac{|F_0(j\omega)|}{e}, \quad (6)$$

The normalisation factor e may be calculated as

$$e = \frac{C}{A_f}. \quad (7)$$



4.2.4 FCR circles

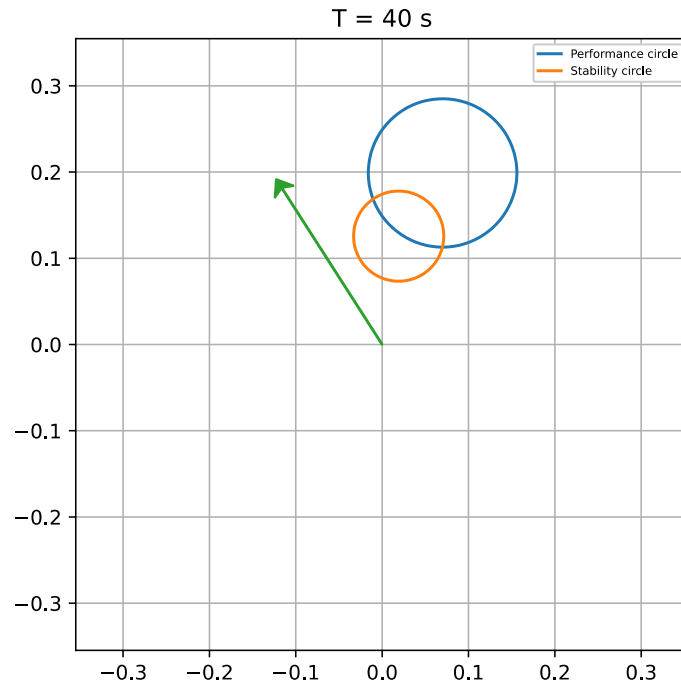


Figure 11. Performance and stability circle for a period time of $T = 40$ s. An arrow with the head pointing outside of the respective circle indicates compliance with the respective requirement for that specific period time.

The FCR circle consists of performance and stability circles, respectively. The performance circles are a graphical illustration of the performance criterion written as

$$\left| F(s) - \frac{1}{G_{avg}(s)} \right| > |D(s)|. \quad (8)$$

For compliance with the performance requirement the arrows – corresponding to the transfer function $F(s)$ – is to point outside of the performance circle, with radius $|D(s)|$ and centred at $1/G_{avg}(s)$.

The stability circles are a graphical illustration of the stability criterion written as

$$\left| F(s) - \frac{1}{G_{min}(s)} \right| > \frac{1}{M_s |G_{min}(s)|}. \quad (9)$$

For compliance with the stability requirement the arrows – corresponding to the transfer function $F(s)$ – is to point outside of the circle, with radius $1/(M_s \cdot |G_{min}(s)|)$ and centred at $1/G_{min}(s)$.

4.2.5 Sensitivity Bode

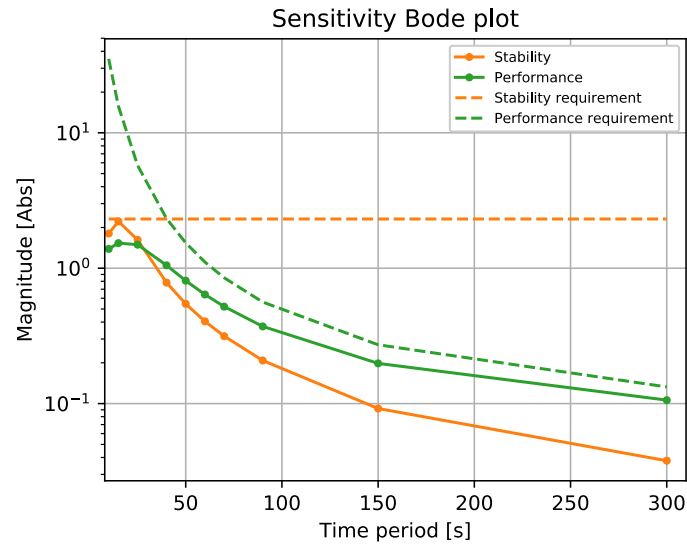


Figure 12. Example of a bode plot on the sensitivity functions. Each solid line is to be below the dashed line of corresponding color for fulfilment.

$ S_{avg}(s) < \frac{1}{ D(s)G_{avg}(s) }$	$ S_{min}(s) < M_s = 2.31$
---	-----------------------------

The Bode plot for the sensitivity functions illustrates the performance and stability requirements respectively as conditions on the sensitivity transfer function, via the equations given in the table above. The performance condition is based on the average inertia system while the sensitivity condition is based on the minimal inertia system. For fulfilment of each requirement each solid line should be below the dashed line of equal colour.

4.2.6 Stability Nyquist

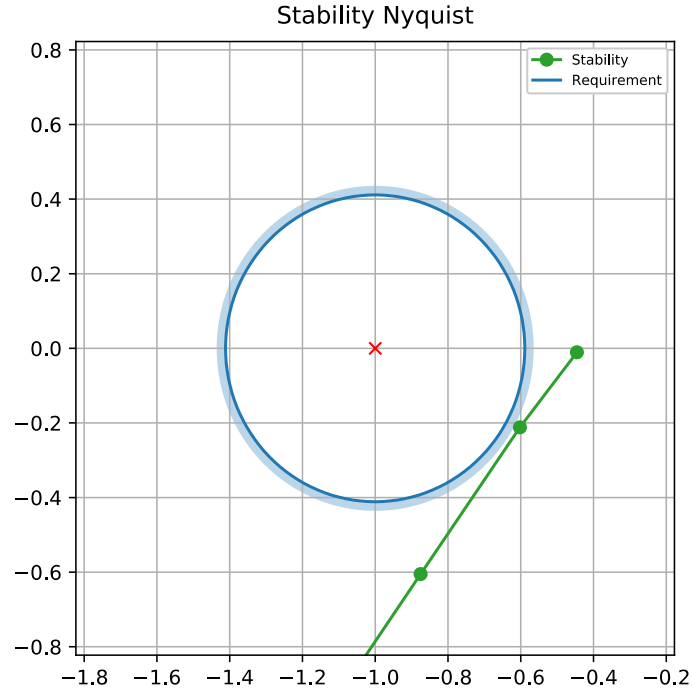


Figure 13. Nyquist plot for the FCR-N stability criterion. The dark blue circle represents the requirement after the 5% reduction. The shaded light blue area represents the requirement without any reductions.

The Nyquist plot on stability is based on the following formulation of the stability requirement:

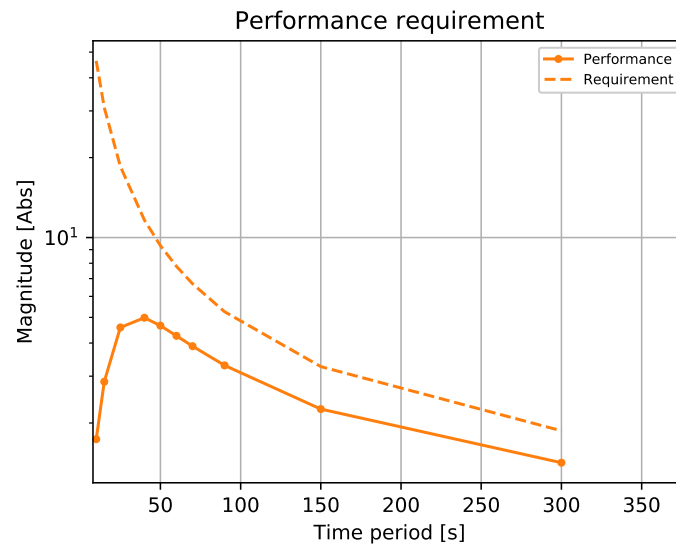
$$|1 - F(s)G_{\min}(s)| > \frac{1}{M_s} \quad (10)$$

The actual plot is created by plotting the real and imaginary parts of

$$G_O(s = j\omega) = -F(s)G_{\min}(s) \quad (11)$$

at the x and y axes respectively, for the applied angular frequencies ω . The interpolated curve is to not enter a circle centred at $x = -1$ with radius $1/M_s$ for fulfilment of the stability criterion. As per usual for a Nyquist plot, the curve should also not encircle the point $(x, y) = (-1, 0)$, i.e. the curve is not allowed to cross the x axis to the left of that point.

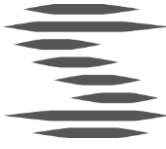
4.2.7 Performance Bode



The Bode plot for the performance requirement is based on the following equation

$$\frac{|G_{avg}(s)|}{|1 - F(s)G_{avg}(s)|} < \frac{1}{|D(s)|}, \quad (12)$$

which is a reformulation of the performance requirement. The interpolated solid line is to be below the dashed requirement line for fulfilment of the condition.



4.3 FCR-D – General

The FCR-D capacity C_{FCR-D} of a pre-qualified unit is calculated as

$$C_{FCR-D} = \min \left(\left| \frac{\Delta P_{7.5s}}{0.86} \right|, |\Delta P_{ss}|, \left| \frac{E_{7.5s}}{3.2s} \right| \right), \quad (13)$$

where ΔP_{ss} is the steady-state response from the FCR-D ramp sequence, $\Delta P_{7.5s}$ is the response 7.5 s after the initiation of the ramp in the ramp sequence while $E_{7.5s}$ is the net-contributed energy during the same time period. For further details on the calculations of each response, refer to the sections that follows.

4.4 FCR-D - Plots

4.4.1 Ramp response

The FCR-D ramp sequence is used to calculate the active power response $\Delta P_{7.5s}$ 7.5 seconds after the initiation of the ramp, as well as the net contributed energy supplied during those 7.5 seconds, denoted $E_{7.5s}$. Both of the resulting parameters are used in the capacity determination equation in (13).

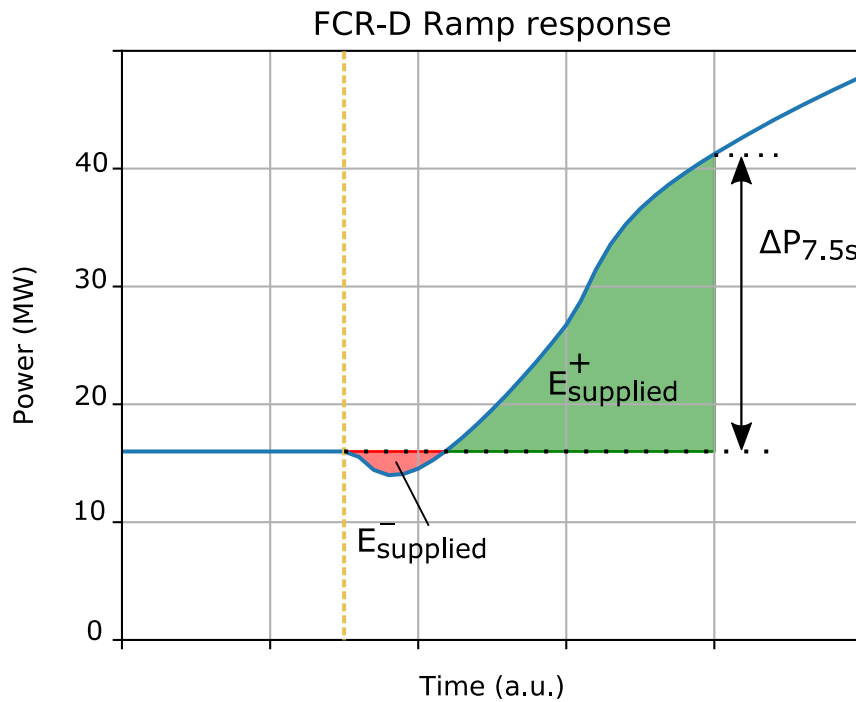


Figure 14. FCR-D upwards ramp response with definitions. FCR-D downwards is defined analogously. $\Delta P_{7.5s}$ is the response 7.5 s after the initiation of the ramp, indicated by the yellow dashed line. The supplied energy 7.5 s after the start of the ramp is here deconstructed into a positive contribution $E_{supplied}^+$ in green, and a negative contribution $E_{supplied}^-$ in red. Thus, $E_{7.5s} = E_{supplied}^+ - E_{supplied}^-$.

4.4.2 Sine sweeps

The sine sweeps for FCR-D is handled in exactly the same way as for FCR-N, described in the sections *Sine sweeps* and *F Bode* above.

4.4.3 Stability Nyquist

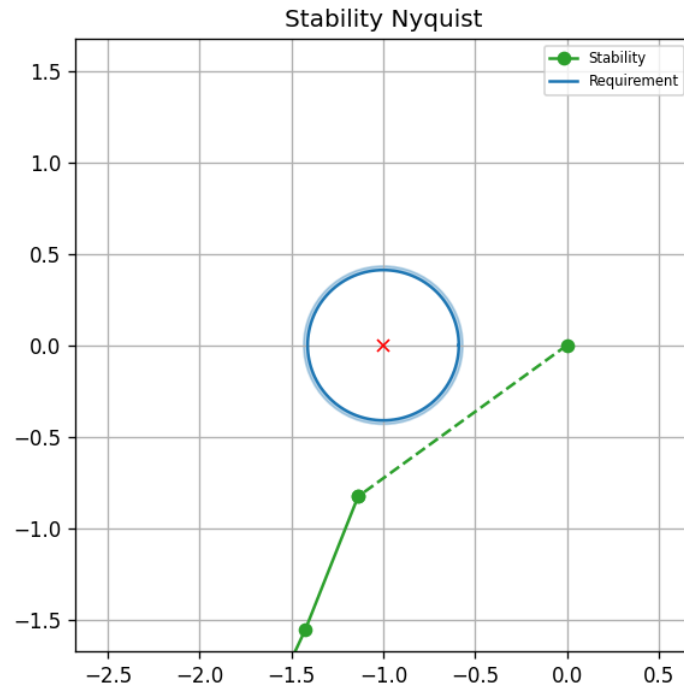


Figure 15. Nyquist plot for the FCR-D stability criterion. The dark blue circle represents the requirement after the 5% reduction. The shaded light blue area represents the requirement without any reductions.

The Nyquist plot on stability for FCR-D is defined analogously to the definition for FCR-N, but for a different representation of the grid transfer function. The grid transfer function for the FCR-D evaluation is taken to be:

$$G(s) = \frac{\Delta P_{ss}}{C_{FCR-D}} \cdot \frac{1450 \text{ MW}}{0.4 \text{ Hz}} \cdot \frac{f_0}{S_n} \cdot \frac{1}{2Hs + k \cdot f_0} \quad (14)$$

Here ΔP_{ss} is the steady state activation from the FCR-D step response sequence defined above, and C_{FCR-D} is the determined FCR-D capacity. The constants take values as presented in the table below.

f_0	50 Hz
S_n	23 000 MW
H	$\frac{120\,000 \text{ MWs}}{S_n}$
k	0.01

Note that the FCP requirements allow for a 5 % reduction of the FCR-D stability



requirement to allow for measurement uncertainties during testing, etc. Such reductions have been omitted from the equations stated in this document, but is included in the calculations performed by the tool. The reduction is also illustrated in the Nyquist plot on stability in Figure 15 above.

4.4.4 Linearity

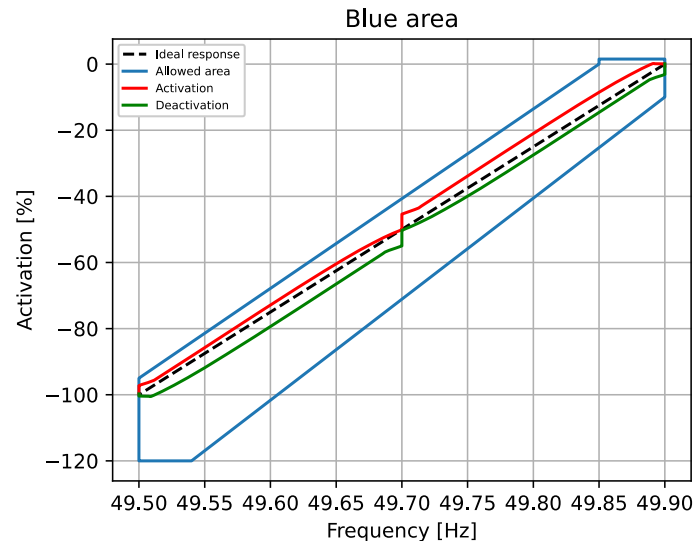


Figure 16. Plot of the linearity of the response in relation to the requirement, i.e. the "blue area".

This section of the IT-Tool has just been introduced as an early version of the planned implementation and is thus still in development.

5 References

The full documentation on the requirements and the stipulated test procedures is available in the documents produced by the series of FCP projects, corresponding to reference [1]-[6] below.

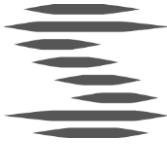
- [1] FCR-N Design of requirements

Available on request

- [2] FCR-D Design of requirements

Available on request

- [3] FCR-D Design of requirements – phase 2



Available: [Svk.se](http://svk.se)

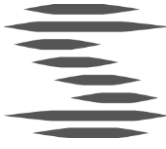
- [4] Technical requirements for frequency containment reserve provision in the Nordic synchronous area

Will be made available shortly

- [5] Test Program for Prequalification of FCR in the Nordic Synchronous Area

Will be made available shortly

- [6] Henrik Ekestam et al. "ICT-tool for assessment of the performance and stability of frequency containment reserves in the Nordic synchronous area". (CIGRÉ Session 2020 [C4-125])



Appendix A: Step response regression model

A regression model has been developed in order to analyse the results from the FCR-N and FCR-D step sequences, as illustrated in Figure 17 below. The fitting is accomplished by performing piece-wise non-linear Gauss-Newton iterations with boundary conditions for continuity. This appendix contains a brief overview of the *Gauss-Newton method* followed by a depiction of the model applied to each step in the sequence as well as the boundary conditions in-between each step.

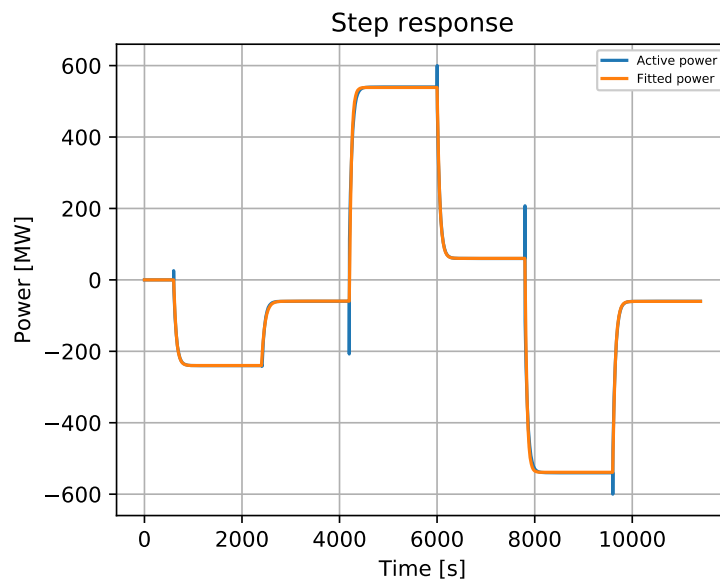


Figure 17. Regression model applied to a simulated step response. The blue line represents the measurement values while the orange line represents the results of the regression.

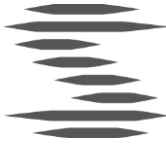
5.1 Gauss-Newton method

The Gauss-Newton method is applied separately for each step in the sequence.

Some assumptions constitute a basis for the use of the method:

- We have a known set of measurement values, denoted \vec{y}_0
- A corresponding set of time values at which the measurements were made, denoted \vec{t}_0 .
- A model function with some parameters that is to be fitted to \vec{y}_0 and \vec{t}_0 by varying the values of the parameters. Denote the set of parameters \vec{k} and the model function $y(\vec{k}, \vec{t})$. The parameters may have a non-linear relationship to the model function.

The idea behind the Gauss-Newton method is to minimise the difference between the model function and the measurement values, at the points in time where the measurements were made, i.e.



$$\min_{\vec{k}} |y(\vec{k}, \vec{t}_0) - \bar{y}_0| \quad (15)$$

For ease of reading, introduce the helper function $F(\vec{k}, \vec{t}) = y(\vec{k}, \vec{t}) - \bar{y}_0$. In the ideal case, we would like to fit the parameters \vec{k} such that $F(\vec{k}, \vec{t}_0) = 0$. Generally, this is not possible, in which case we would instead like to find the closest solution in the least-square sense. This may be formally formulated as

$$\min_{\vec{k}} \|F(\vec{k}, \vec{t}_0)\|^2. \quad (16)$$

The first step in the Gauss-Newton method is to assume that it is possible to find the ideal solution $F(\vec{k}, \vec{t}_0) = 0$ by performing a first order Taylor expansion in the parameters \vec{k} . Based on some initial guess \vec{k}_0 on the values of \vec{k} , we get the expansion

$$F(\vec{k}, \vec{t}_0) = F(\vec{k}_0, \vec{t}_0) + F'_k(\vec{k}_0, \vec{t}_0) \cdot \overline{\Delta k}. \quad (17)$$

Here $J = F'_k(\vec{k}_0, \vec{t}_0)$ is the derivative (denoted Jacobian) of F with respect to \vec{k} , and $\overline{\Delta k}$ is the first order correction to the initial guess \vec{k}_0 . As we seek the ideal solution $F(\vec{k}, \vec{t}_0) = 0$, we find that the first order correction is to be

$$\overline{\Delta k} = -J^{-1} \cdot F(\vec{k}_0, \vec{t}_0). \quad (18)$$

As previously mentioned, in general the ideal solution does not exist, as the number of free parameters in \vec{k} is less than the number of measurements in y_0 . The result of this is that the Jacobian J becomes over-determined, and hence non-invertible. The method applied to be able to continue is to instead search for the closest solution in the least-squares sense. Per usual this is performed by multiplying the equation with the transpose of the over-determined matrix, i.e.

$$\overline{\Delta k} = -(J^T J)^{-1} J^T \cdot F(\vec{k}_0, \vec{t}_0). \quad (19)$$

This reduces to (18) if the Jacobian happens to be invertible.

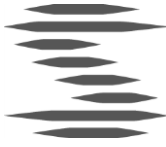
The correction in (19) is applied iteratively until some stop condition is reached, e.g. until the norm of the correction is smaller than some small number ϵ :

$$\|\overline{\Delta k}\| < \epsilon. \quad (20)$$

5.2 Regression model

This section contains a description of the regression model applied to the step sequences for FCR-N and FCR-D respectively. For each step in the sequence a model function of

$$y(t) = ae^{-bt} + c \quad (21)$$



is fitted using the Gauss-Newton method outlined above. Here the parameter a constitutes the amplitude of the fitted response. The parameter b corresponds to the time constant τ of the step through the relation $\tau = 1/b$. The parameter c determines the steady-state response level after the step.

The model function in (21) is separately applied to each respective step in the sequence. Since no regard is taken to data outside of the interval for each respective step spurious discontinuities were obtained at the transition from one step to the next. As a remedy a boundary condition were implemented as an addition to (21) in order to force a continuous regression even when transitioning between steps in the sequence. The parameter a were thus corrected such that the step response would start at a desired level denoted y_0 , equal to the value of c for the preceding step. This condition corresponds to forcing the step response to start at the same level as the preceding step ended at. The boundary condition becomes

$$a = y_0 - c , \quad (22)$$

leading to a modified model function

$$y(t) = (y_0 - c)e^{-bt} + c . \quad (23)$$